

4.9-5.8 GHz High-Linearity Power Amplifier

SST11LP12



Preliminary Specifications

FEATURES:

- **High Gain:**
 - Typically 35 dB gain across 4.9-5.8 GHz over temperature 0°C to +85°C
- **High linear output power:**
 - ~28 dBm P1dB (Pulsed single-tone signal)
 - Meet 802.11a OFDM ACPR requirement up to 23+ dBm over ~ entire band
 - Added EVM~4% up to 21 dBm for 54 Mbps 802.11a signal
- **High power-added efficiency/Low operating current for 54 Mbps 802.11a applications**
 - ~12% @ $P_{OUT} = 21$ dBm for 54 Mbps
- **Built-in Ultra-low I_{REF} power-up/down control**
 - $I_{REF} < 3$ mA
- **Low idle current**
 - ~130 mA I_{CQ}
- **High speed power up/down**
 - Turn on/off time (10%~90%) <100 ns
 - Typical power-up/down delay with driver delay included <200 ns
- **High temperature stability**
 - ~1.5/1.0 dB gain/power variation between 0°C to +85°C
 - ~1 dB detector variation over 0°C to +85°C
- **Low shut-down current (< 0.1 μ A)**
- **On-chip power detection**
- **20 dB dynamic range on-chip power detection**
- **Simple input/output matching**
- **Packages available**
 - 16-contact WQFN (3mm x 3mm)
 - Non-Pb (lead-free) packages available

APPLICATIONS:

- **WLAN (IEEE 802.11a)**
- **Japan WLAN**
- **HyperLAN2**
- **Multimedia**

PRODUCT DESCRIPTION

The SST11LP12 is a high-power, high-gain power amplifier based on the highly-reliable InGaP/GaAs HBT technology.

The SST11LP12 can be easily configured for high-power, high-efficiency applications with superb power-added efficiency while operating over the entire 802.11a frequency band for U.S., European, and Japanese markets (4.9-5.8 GHz). It typically provides 35 dB gain with 16% power-added efficiency @ $P_{OUT} = 23$ dBm.

The SST11LP12 has excellent linearity, typically ~4% added EVM at 21 dBm output power which is essential for 54 Mbps 802.11a operation while meeting 802.11a spectrum mask at 23+ dBm. SST11LP12 also has wide-range (>20 dB), temperature-stable (~1 dB over 85°C), single-ended/differential power detectors which lower users' cost on power control.

The power amplifier IC also features easy board-level usage along with high-speed power-up/down control. Ultra-low reference current (total $I_{REF} < 3$ mA) makes the SST11LP12 controllable by an on/off switching signal directly from the baseband chip. These features coupled with low operating current make the SST11LP12 ideal for the final stage power amplification in battery-powered 802.11a WLAN transmitter and access point applications.

The SST11LP12 is offered in 16-contact WQFN package. See Figure 1 for pin assignments and Table 1 for pin descriptions.



4.9-5.8 GHz High-Linearity Power Amplifier SST11LP12

Preliminary Specifications

FUNCTIONAL BLOCKS

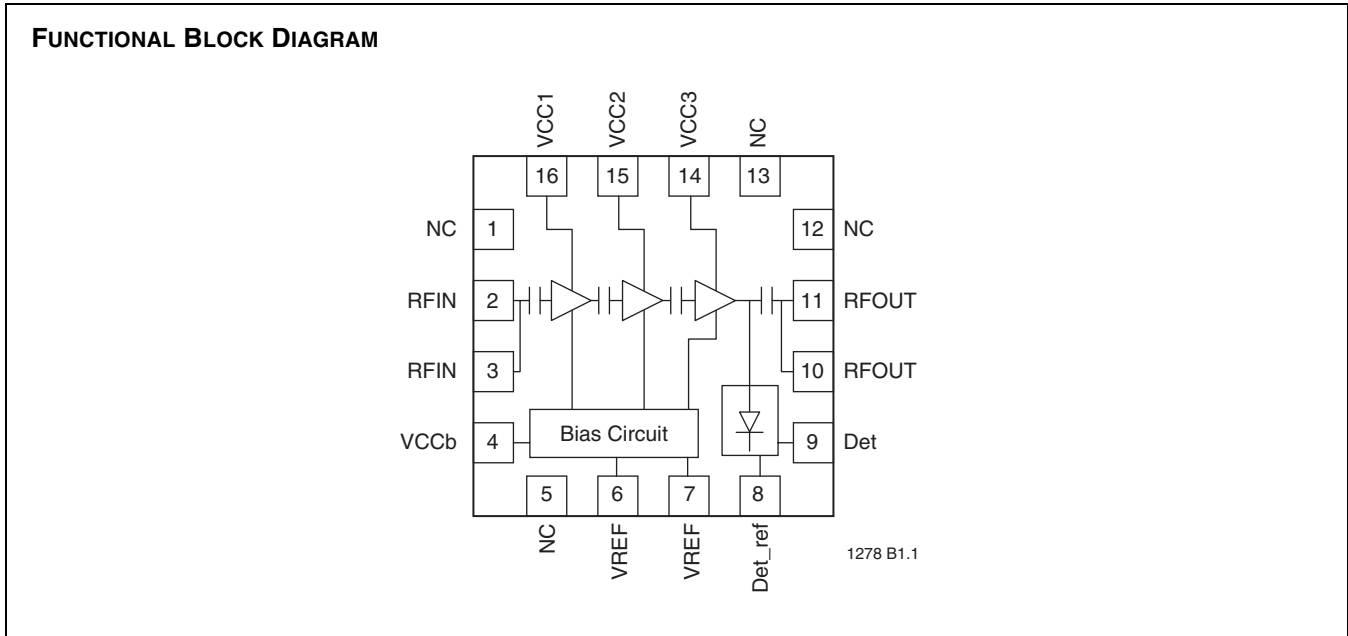



4.9-5.8 GHz High-Linearity Power Amplifier SST11LP12

Preliminary Specifications

PIN ASSIGNMENTS

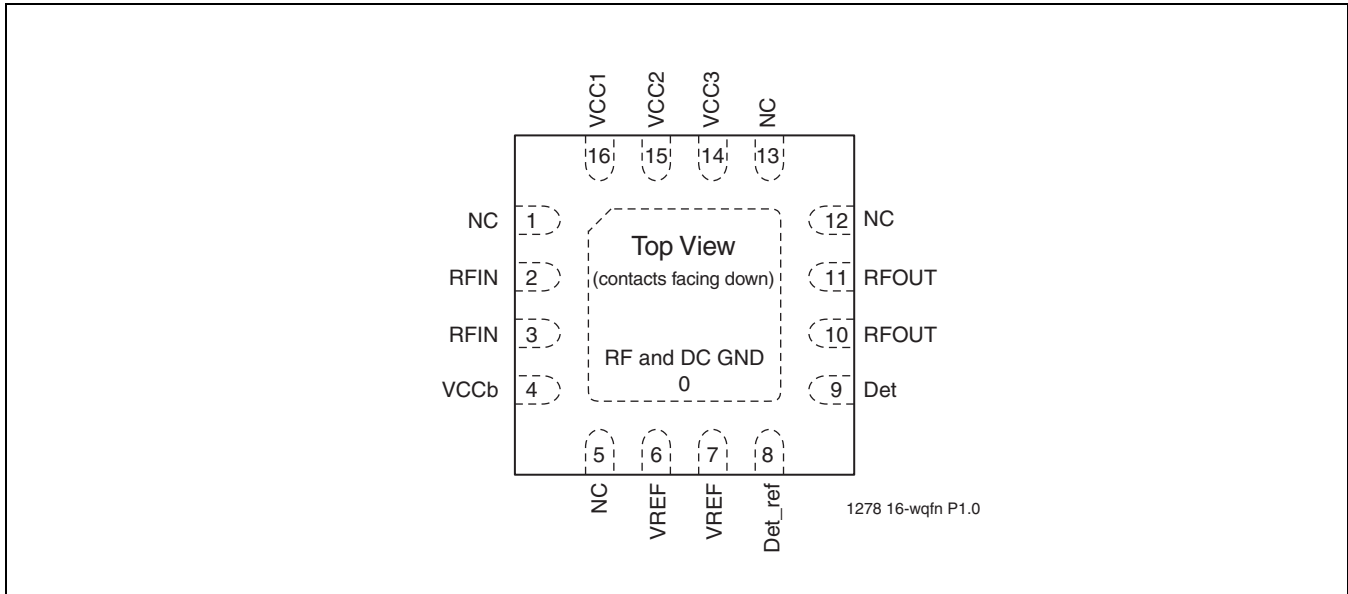

FIGURE 1: PIN ASSIGNMENTS FOR 16-CONTACT WQFN

PIN DESCRIPTIONS

TABLE 1: PIN DESCRIPTION

Symbol	Pin No.	Pin Name	Type ¹	Function
GND	0	Ground		The center pad should be connected to RF ground with several low inductance, low resistance vias.
NC	1	No Connection		Unconnected pin
RFIN	2		I	RF input, DC decoupled
RFIN	3		I	RF input, DC decoupled
VCCb	4	Power Supply	PWR	Supply voltage for bias circuit
NC	5	No Connection		Unconnected pin
VREF	6		PWR	Current Control
VREF	7		PWR	Current Control
Det_ref	8		O	On-chip power detector reference
Det	9		O	On-chip power detector
RFOUT	10		O	RF output
RFOUT	11		O	RF output
NC	12	No Connection		Unconnected pin
NC	13	No Connection		Unconnected pin
VCC3	14	Power Supply	PWR	Power supply, 3rd stage
VCC2	15	Power Supply	PWR	Power supply, 2nd stage
VCC1	16	Power Supply	PWR	Power supply, 1st stage

1. I=Input, O=Output

T1.1 1278



4.9-5.8 GHz High-Linearity Power Amplifier SST11LP12

Preliminary Specifications

ELECTRICAL SPECIFICATIONS

The AC and DC specifications for the power amplifier interface signals. Refer to Table 2 for the DC voltage and current specifications. Refer to Figures 2 through 10 for the RF performance.

Absolute Maximum Stress Ratings (Applied conditions greater than those listed under “Absolute Maximum Stress Ratings” may cause permanent damage to the device. This is a stress rating only and functional operation of the device at these conditions or conditions greater than those defined in the operational sections of this data sheet is not implied. Exposure to absolute maximum stress rating conditions may affect device reliability.)

Supply Voltage at pins 4, 14, 15, 16 (V_{CC}) -0.3V to +5.5V
 DC supply current (I_{CC}) 500 mA
 Operating Temperature (T_A) -40°C to +85°C
 Storage Temperature (T_{STG}) -40°C to +120°C
 Maximum Junction Temperature (T_J) +150°C
 Surface Mount Solder Reflow Temperature 260°C for 10 seconds

OPERATING RANGE

Range	Ambient Temp	V_{CC}
Industrial	-40°C to +85°C	3.3V

TABLE 2: DC ELECTRICAL CHARACTERISTICS

Symbol	Parameter	Min.	Typ	Max.	Unit	Test Conditions
V_{CC}	Supply Voltage at pins 4, 14, 15, 16	2.7	3.3	3.6	V	
I_{CC}	Supply Current @ $P_{OUT} = 23$ dBm at $V_{CC} = 3.3V$			400	mA	
I_{CQ}	V_{CC} quiescent current		130		mA	
I_{OFF}	Shut down current		<1.0		μA	
V_{REG}	Reference Voltage for recommended application		2.85		V	

T2.0 1278



4.9-5.8 GHz High-Linearity Power Amplifier SST11LP12

Preliminary Specifications

TABLE 3: AC ELECTRICAL CHARACTERISTICS FOR CONFIGURATION

Symbol	Parameter	Min	Typ	Max	Unit
F _{L-U}	Frequency range	4.9		5.8	GHz
Linearity	Output power with 4% EVM at 54 Mbps OFDM signal when operating at 3.3V V _{CC}		21		dBm
	Output power level with 802.11a mask compliance across 4.9-5.8 GHz	23			dBm
G	Linear gain across 4.9~5.8GHz	32			dB
G _{VAR}	Gain variation over band (4.9-5.8 MHz)			3	dB
	Gain variation over band (4.9-5.35 MHz)			1.5	dB
	Gain variation over band (5.7-5.8 MHz)			1	dB
	Gain variation over channel (20 MHz)		0.2		dB
Det	Power detector output voltage range	0.5		2.0	V
Det_ref	Power detector output reference	0.5	0.6		V
S	Power detector sensitivity		0.03		V/dB
2f, 3f, 4f, 5f	Harmonics at 22 dBm, without trapping capacitors		-40		dBc

T3.1 1278



4.9-5.8 GHz High-Linearity Power Amplifier SST11LP12

Preliminary Specifications

TYPICAL PERFORMANCE CHARACTERISTICS

TEST CONDITIONS: $V_{CC} = 3.3V$, $T_A = 25^\circ C$, $V_{REG1,2} = 2.85V$ UNLESS OTHERWISE NOTED

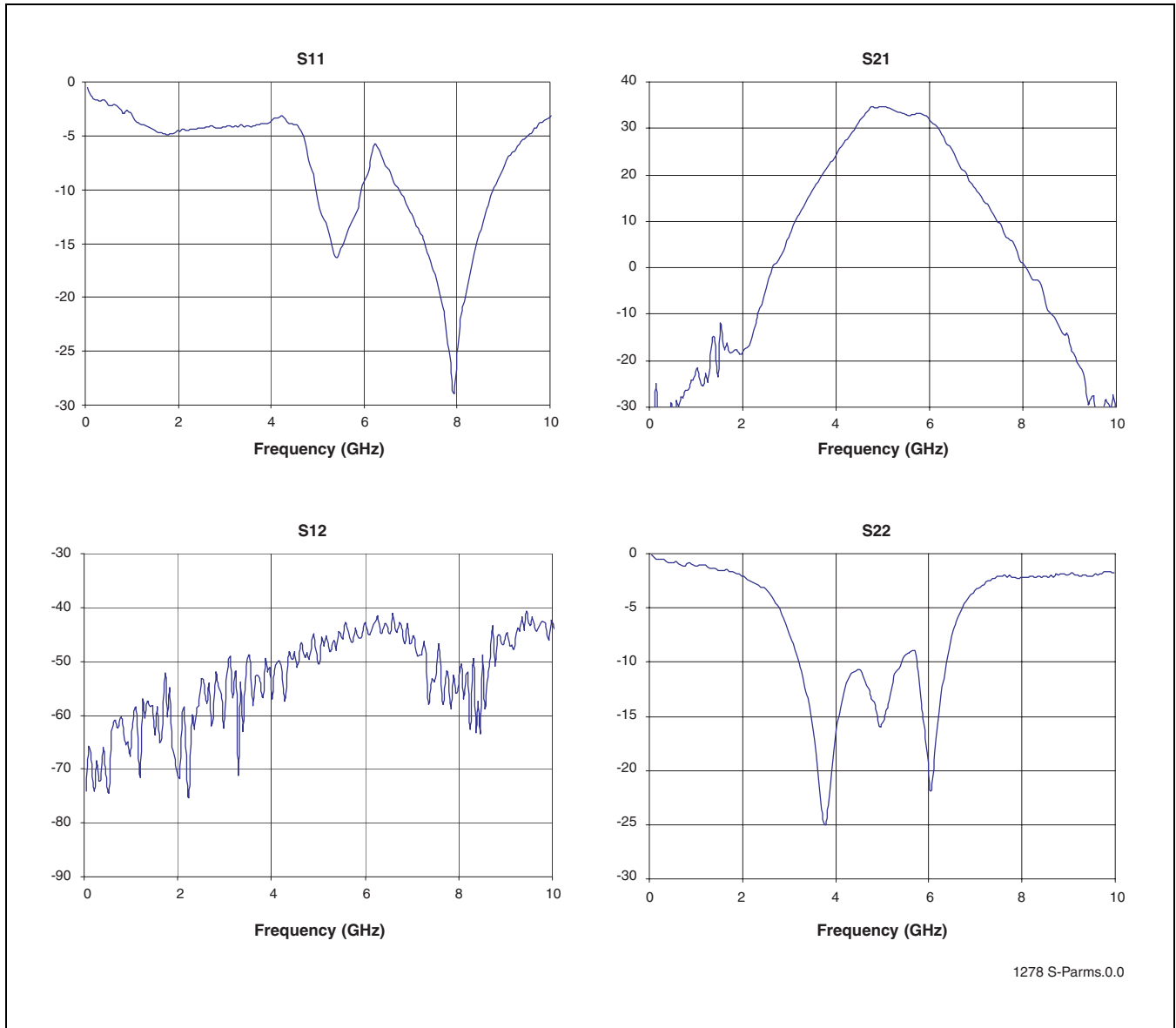

FIGURE 2: S-PARAMETERS

TWO-TONE MEASUREMENTS

TEST CONDITIONS: $\Delta F = 1$ MHz

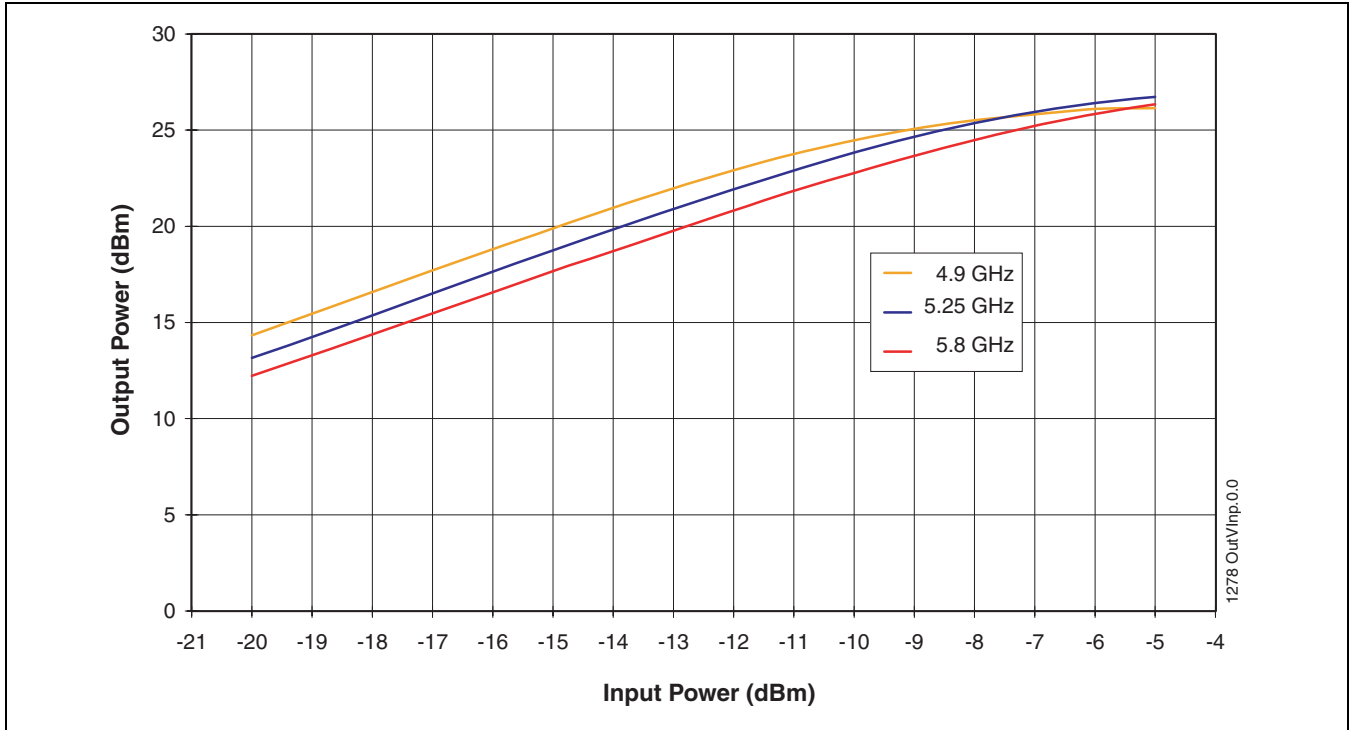

FIGURE 3: OUTPUT POWER VERSUS INPUT POWER

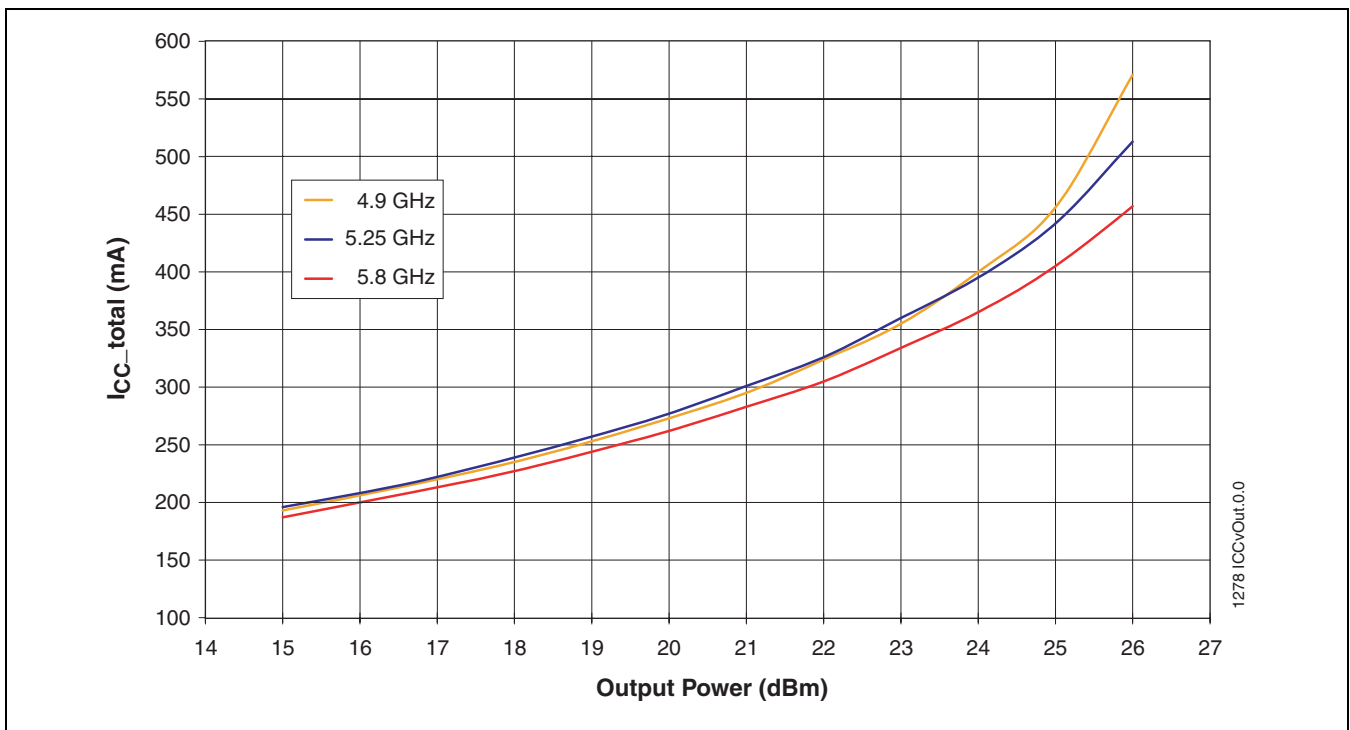

FIGURE 4: POWER SUPPLY CURRENT VERSUS OUTPUT POWER



4.9-5.8 GHz High-Linearity Power Amplifier SST11LP12

Preliminary Specifications

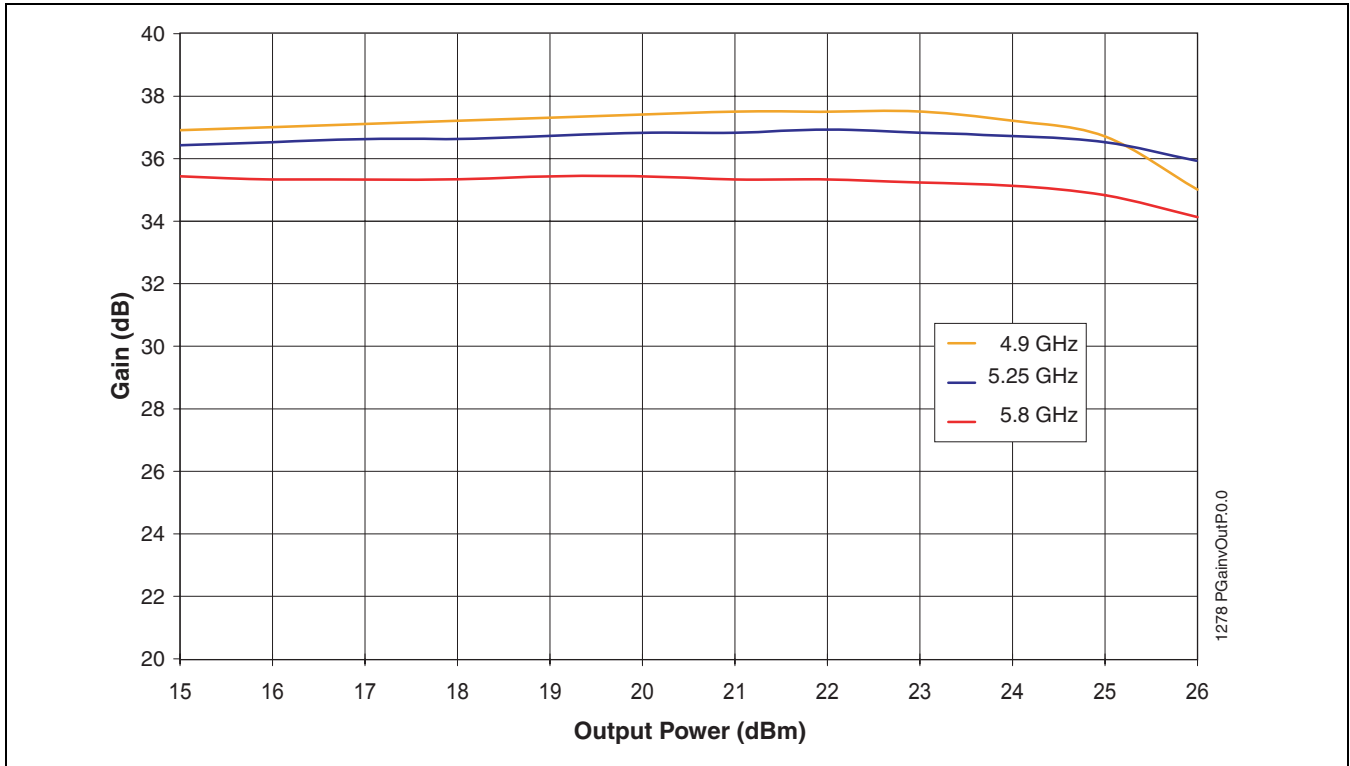

FIGURE 5: POWER GAIN VERSUS OUTPUT POWER

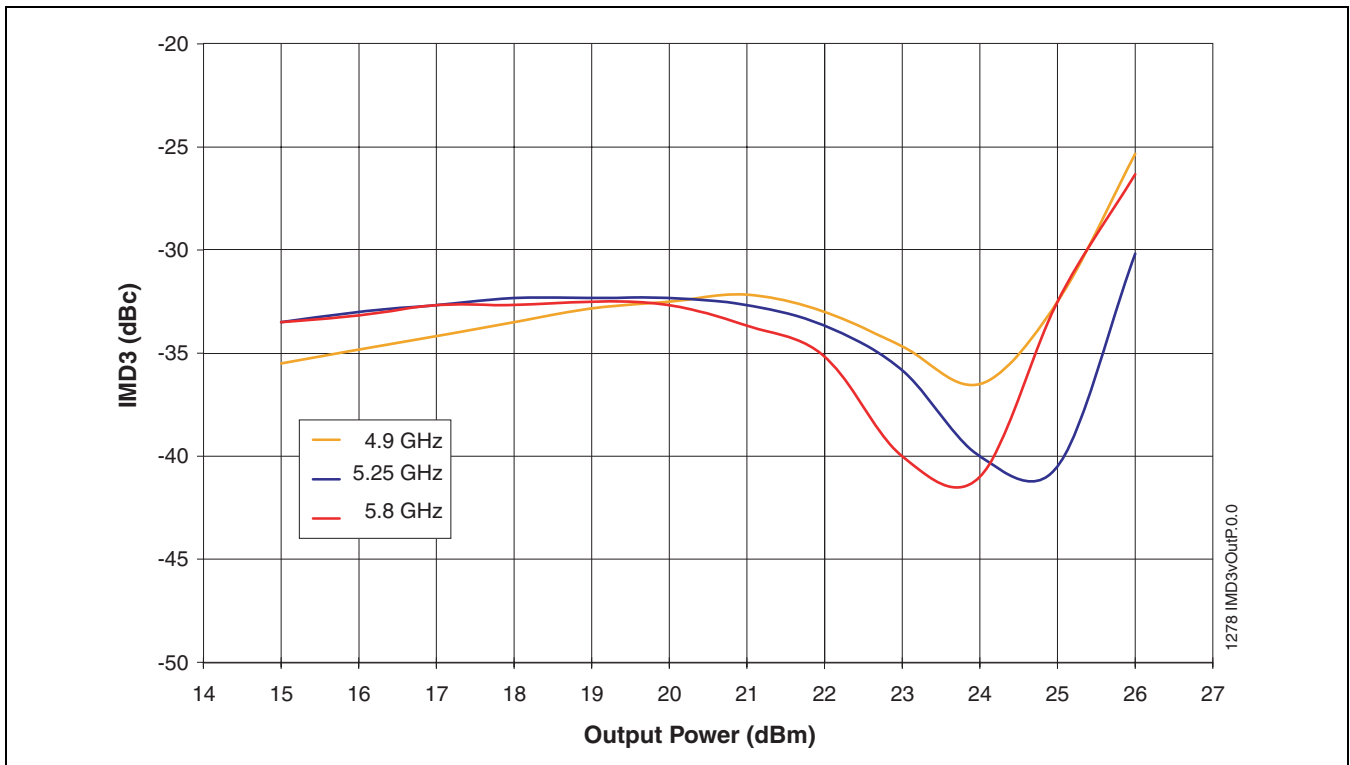

FIGURE 6: IMD3 VERSUS OUTPUT POWER

ACPR FOR 54 MBPS OFDM SIGNALS

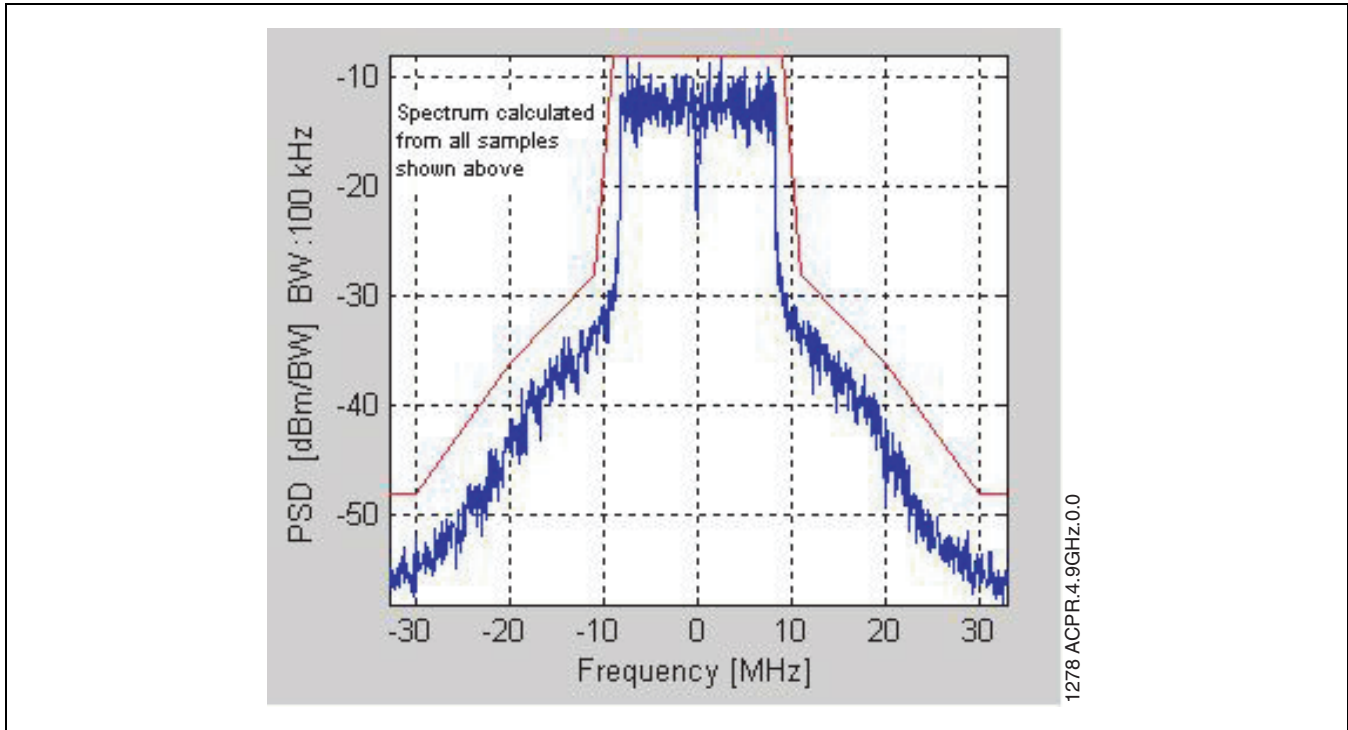

FIGURE 7: FREQUENCY = 4.9 GHz AT $P_{OUT} = 23.5$ DBM WITH $I_{CC} = 395$ MA

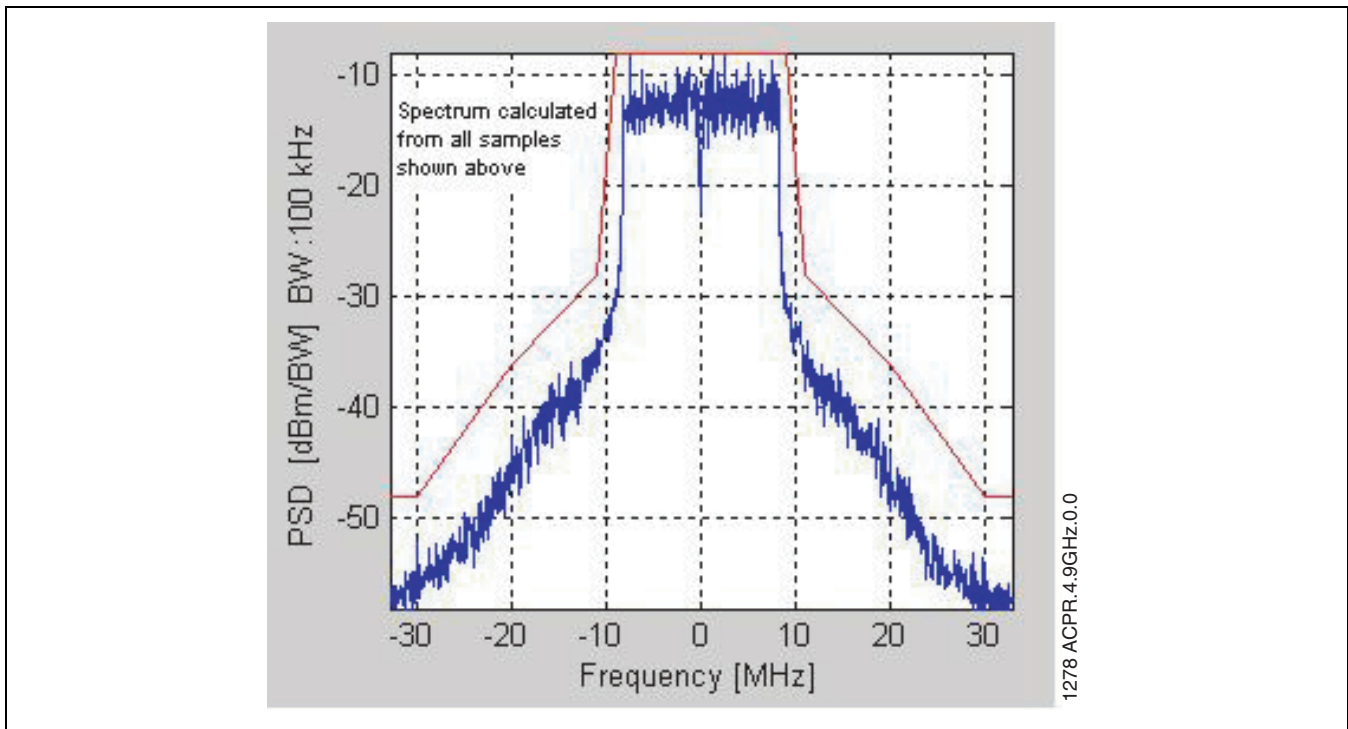

FIGURE 8: FREQUENCY = 5.18 GHz AT $P_{OUT} = 23.5$ DBM WITH $I_{CC} = 390$ MA



4.9-5.8 GHz High-Linearity Power Amplifier SST11LP12

Preliminary Specifications

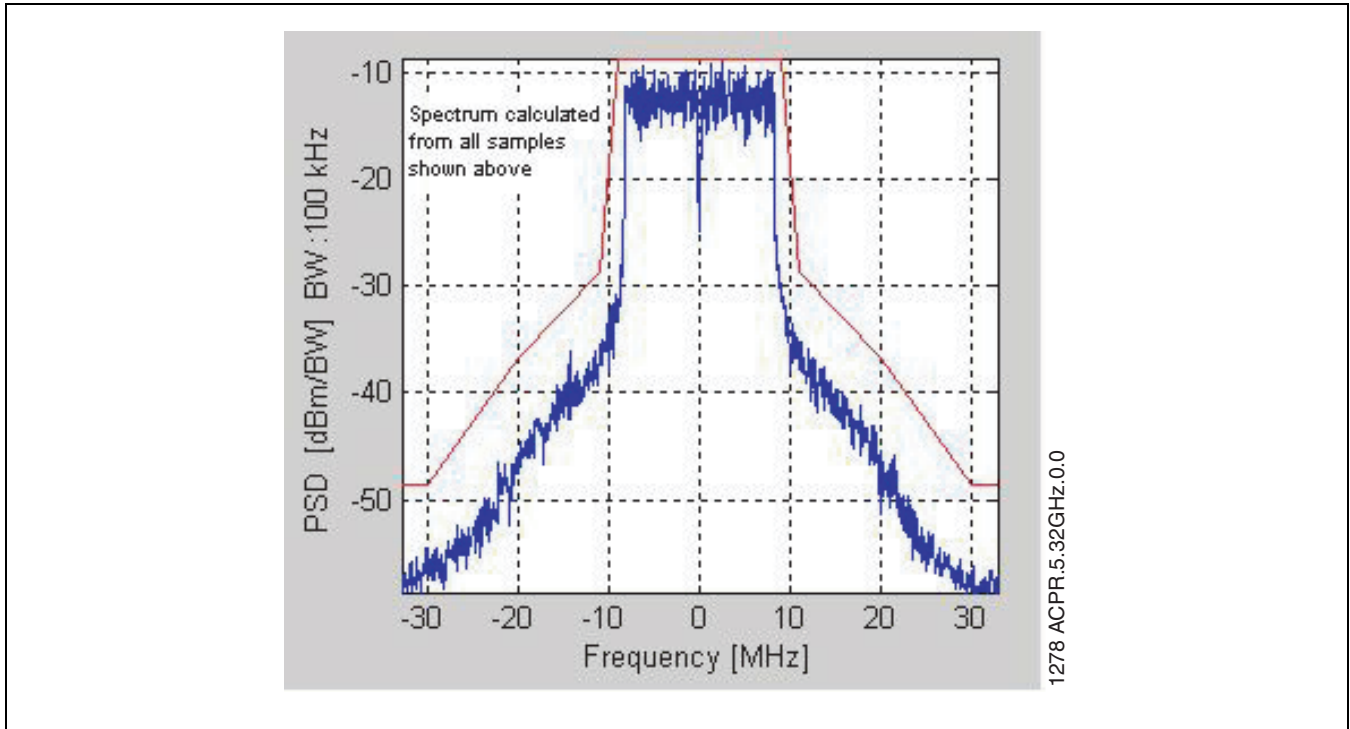

FIGURE 9: FREQUENCY = 5.32 GHz AT $P_{OUT} = 23.5$ DBM WITH $I_{CC} = 385$ MA

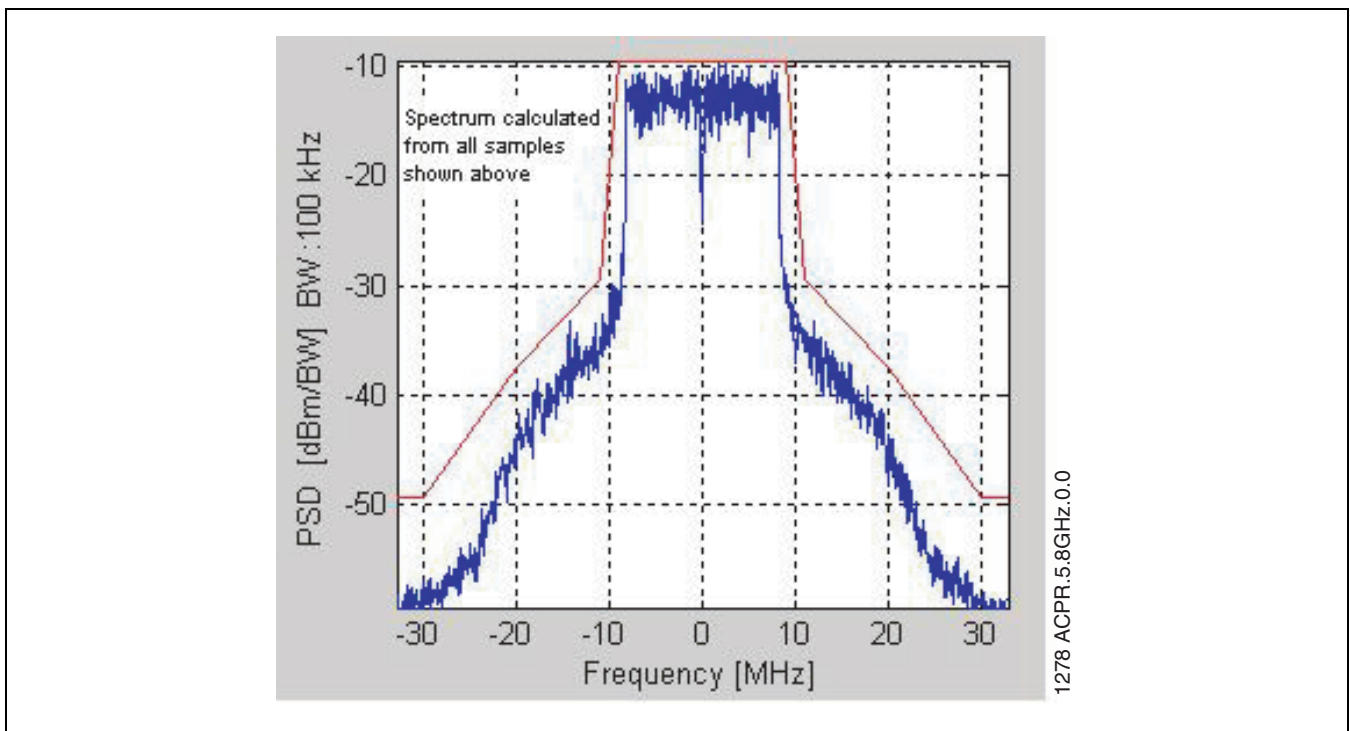

FIGURE 10: FREQUENCY = 5.8 GHz AT $P_{OUT} = 23.5$ DBM WITH $I_{CC} = 365$ MA



4.9-5.8 GHz High-Linearity Power Amplifier SST11LP12

Preliminary Specifications

EVM FOR 54 MBPS OPERATION

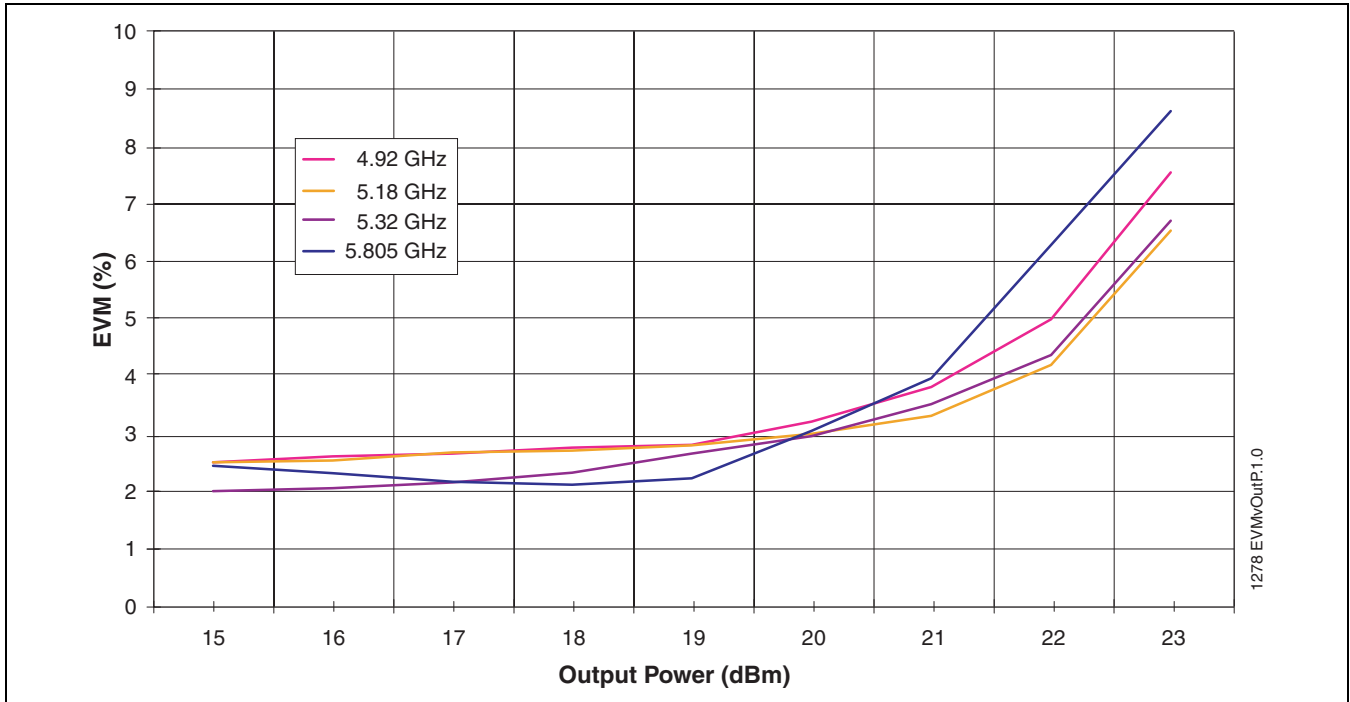

FIGURE 11: EVM VERSUS OUTPUT POWER

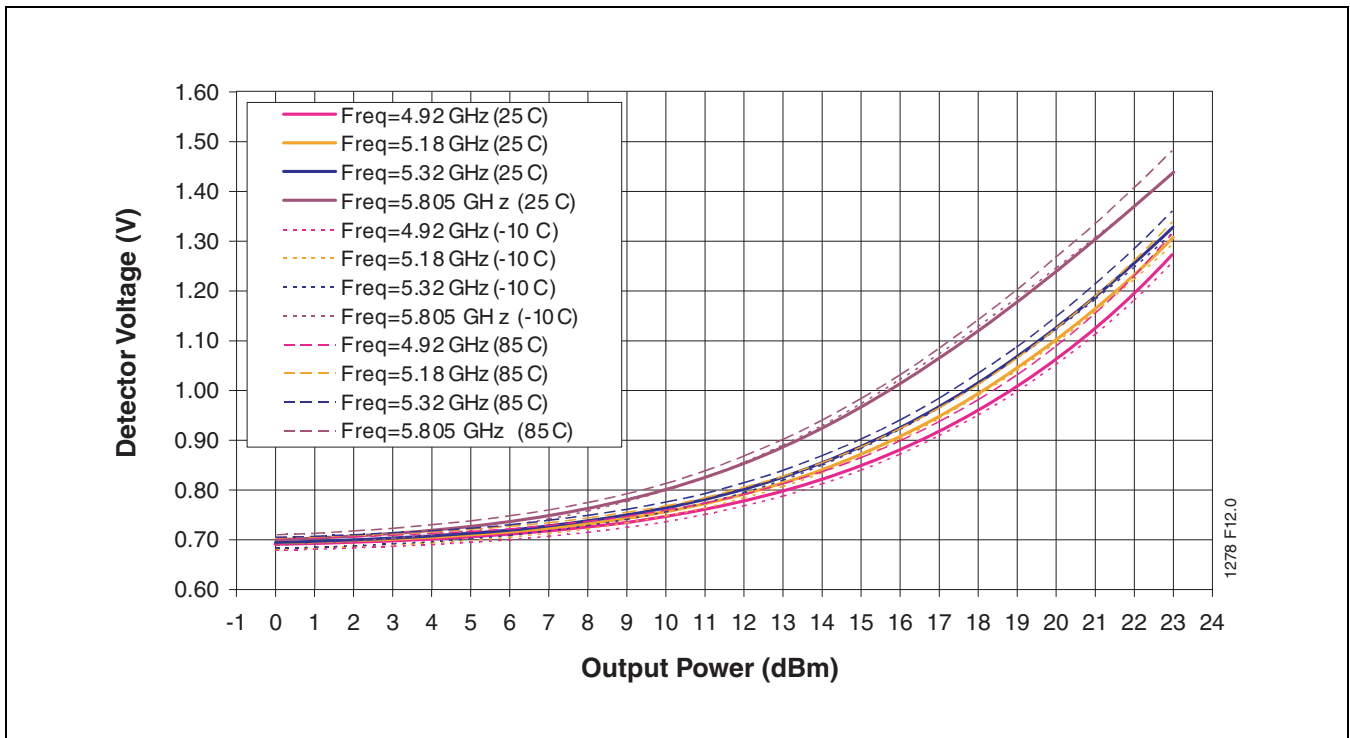
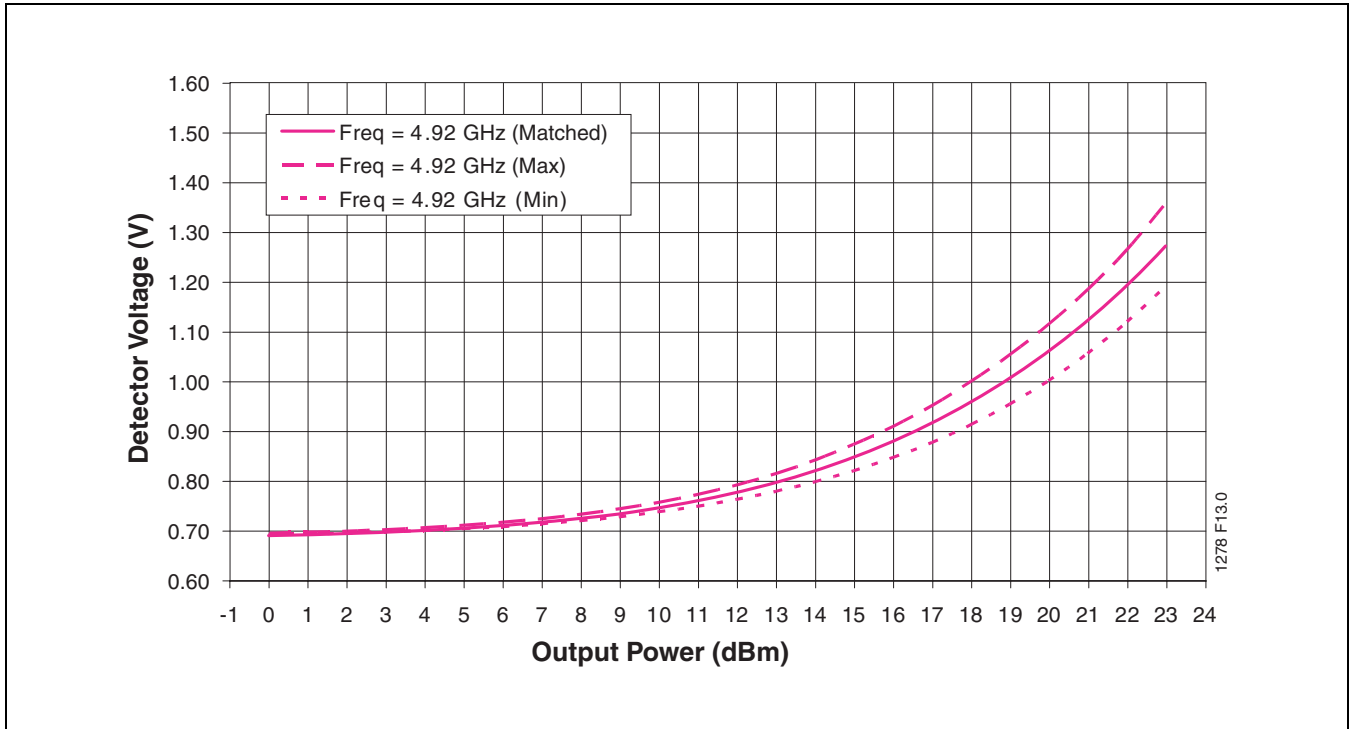

FIGURE 12: DETECTOR CHARACTERISTICS OVER TEMPERATURE AND FREQUENCY



4.9-5.8 GHz High-Linearity Power Amplifier SST11LP12

Preliminary Specifications



**FIGURE 13: DETECTOR CHARACTERISTICS AT ROOM TEMPERATURE WITH 2:1 OUTPUT VSWR
ALL PHASES AT 4.92 GHz**

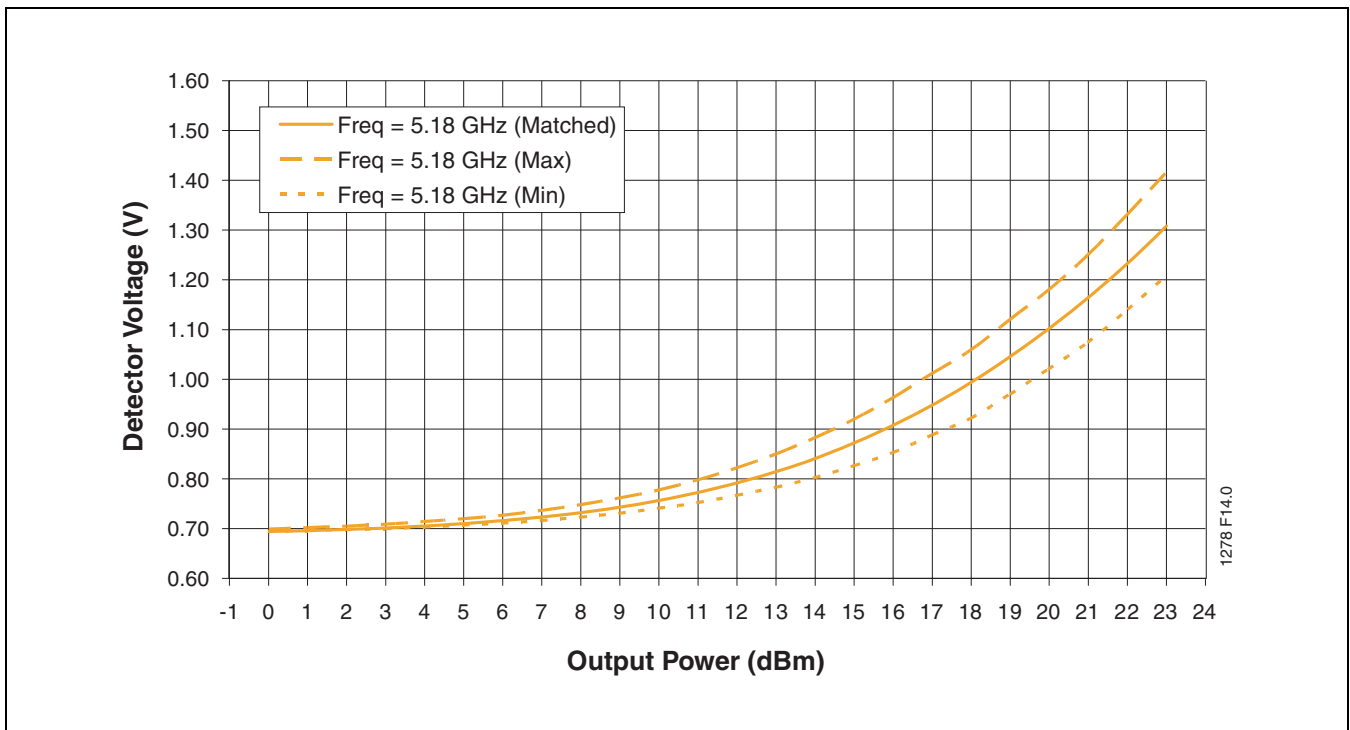
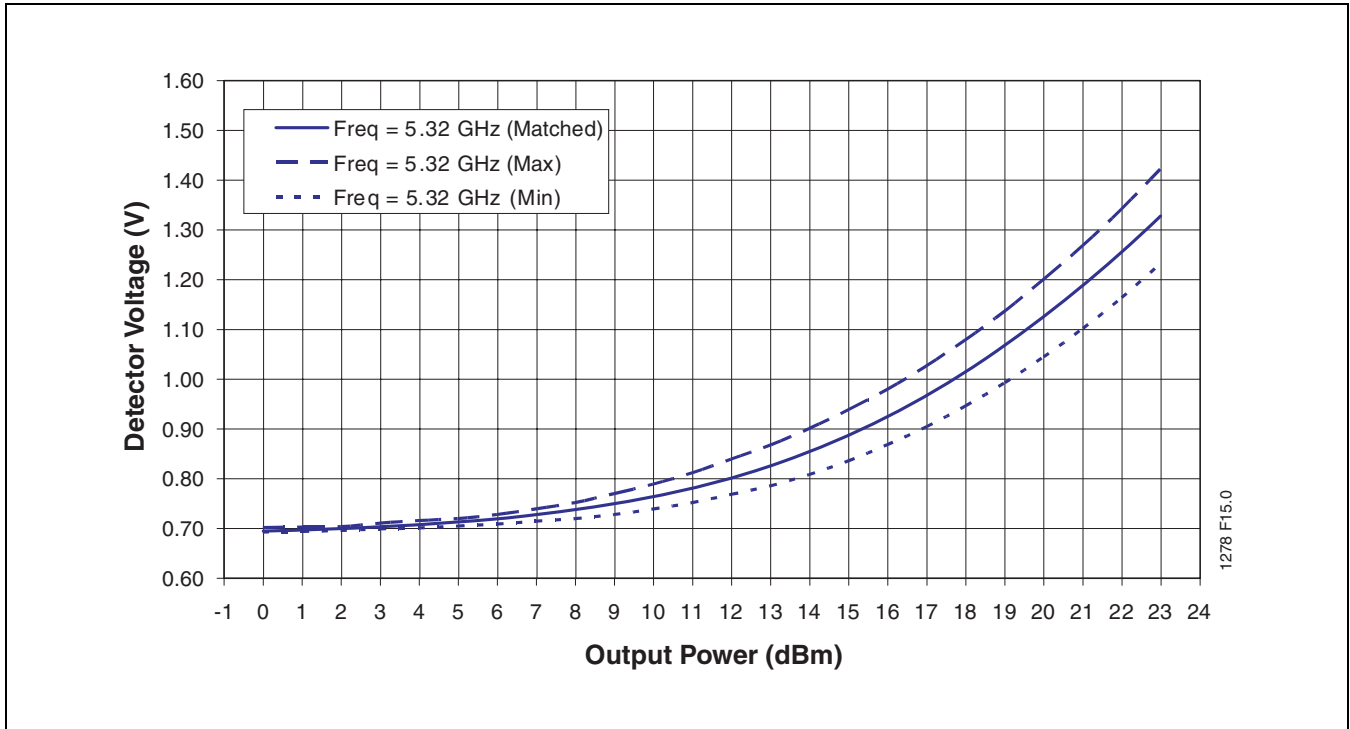

**FIGURE 14: DETECTOR CHARACTERISTICS AT ROOM TEMPERATURE WITH 2:1 OUTPUT VSWR
ALL PHASES AT 5.18 GHz**

4.9-5.8 GHz High-Linearity Power Amplifier SST11LP12



Preliminary Specifications



**FIGURE 15: DETECTOR CHARACTERISTICS AT ROOM TEMPERATURE WITH 2:1 OUTPUT VSWR
ALL PHASES AT 5.32 GHz**

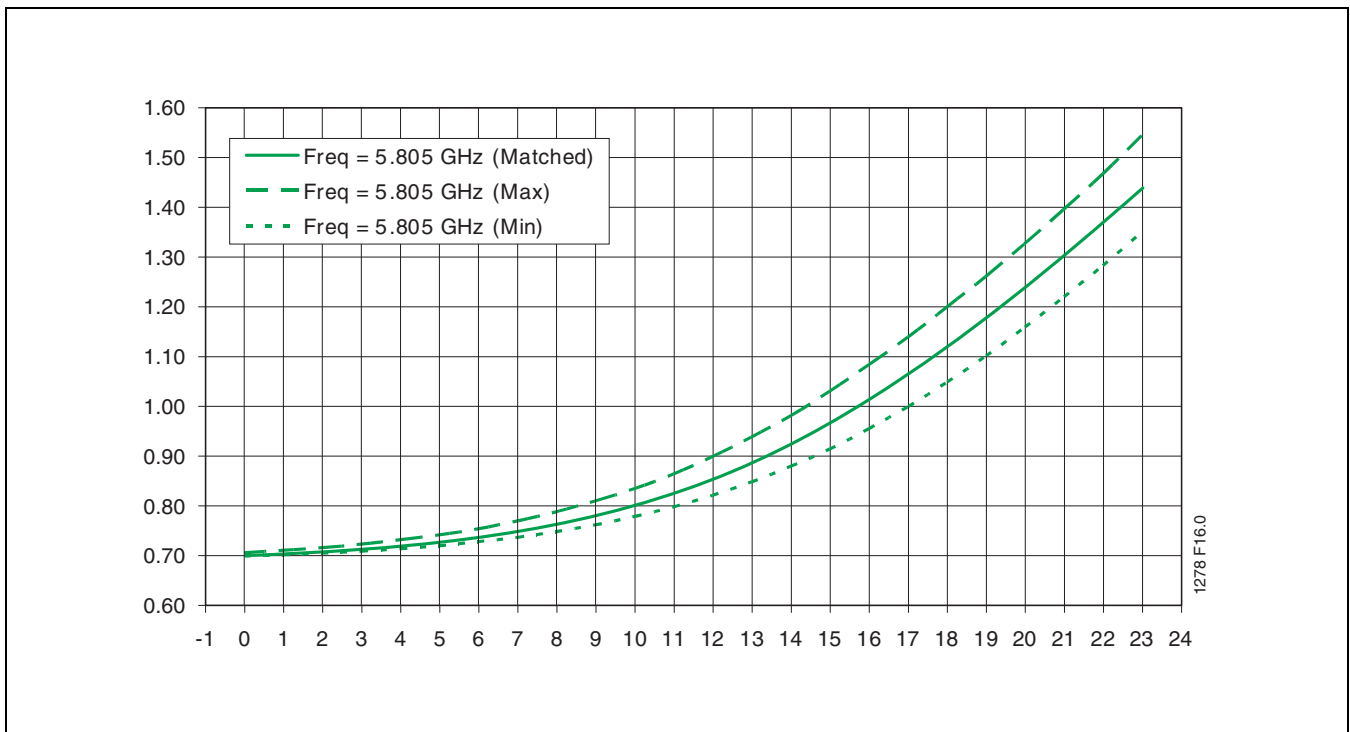

**FIGURE 16: DETECTOR CHARACTERISTICS AT ROOM TEMPERATURE WITH 2:1 OUTPUT VSWR
ALL PHASES AT 5.805 GHz**



4.9-5.8 GHz High-Linearity Power Amplifier SST11LP12

Preliminary Specifications

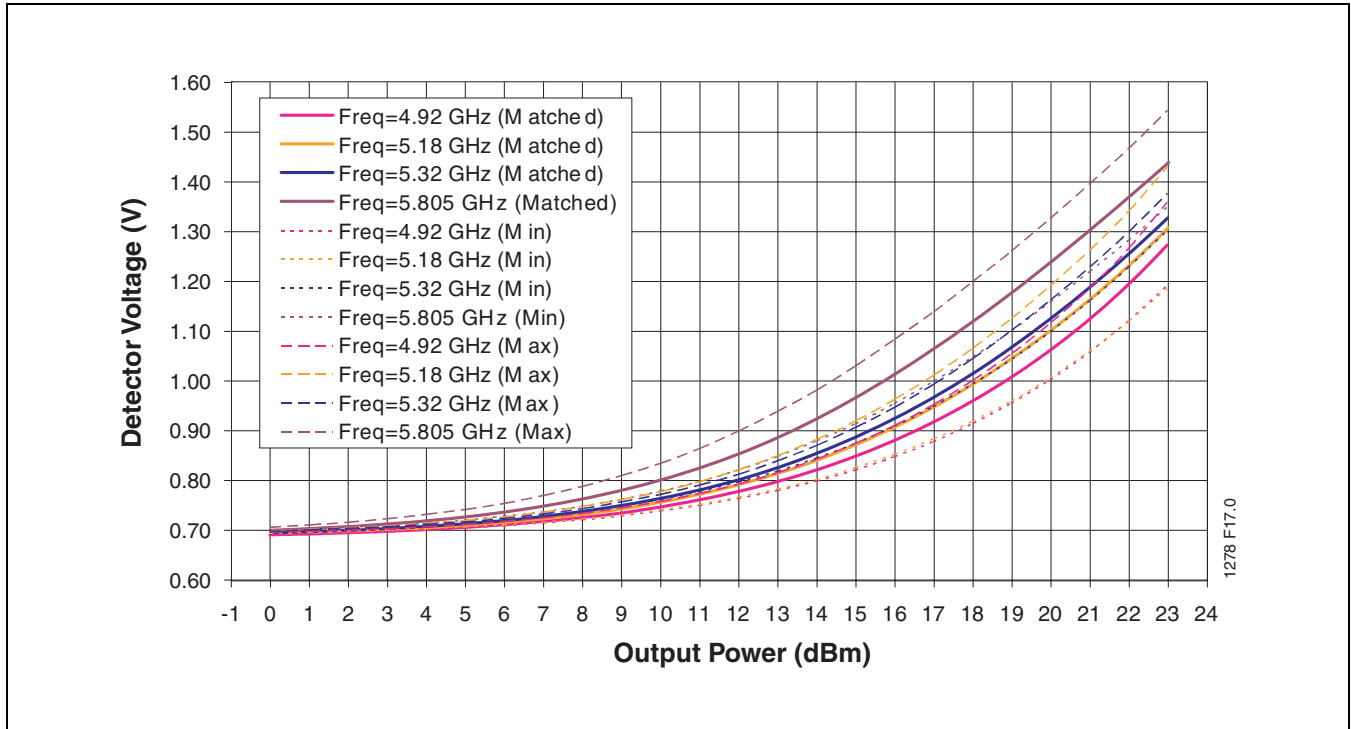

FIGURE 17: DETECTOR CHARACTERISTICS AT ROOM TEMPERATURE OVER FREQUENCY WITH 2:1 OUTPUT VSWR ALL PHASES

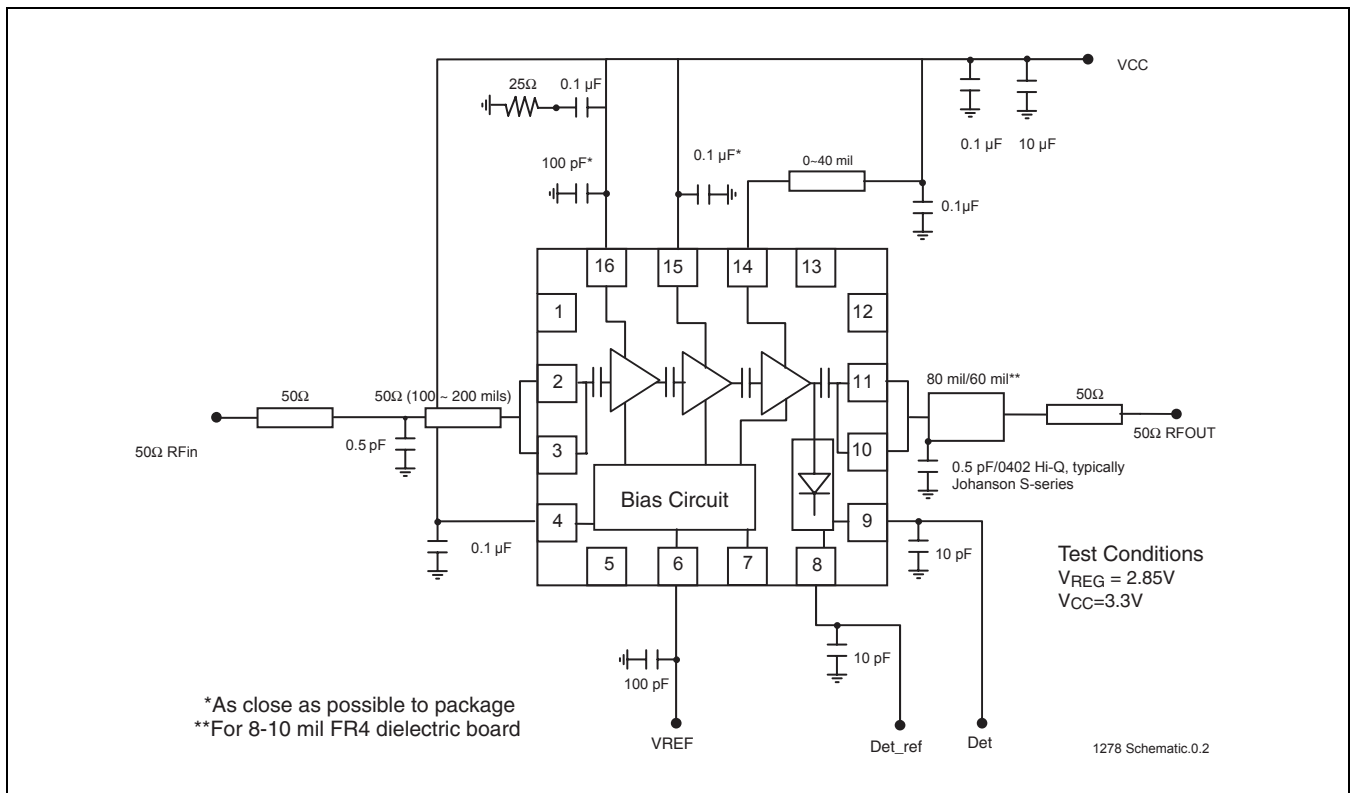

FIGURE 18: TYPICAL APPLICATION FOR HIGH-POWER 802.11A APPLICATION



4.9-5.8 GHz High-Linearity Power Amplifier

SST11LP12

Preliminary Specifications

PRODUCT ORDERING INFORMATION

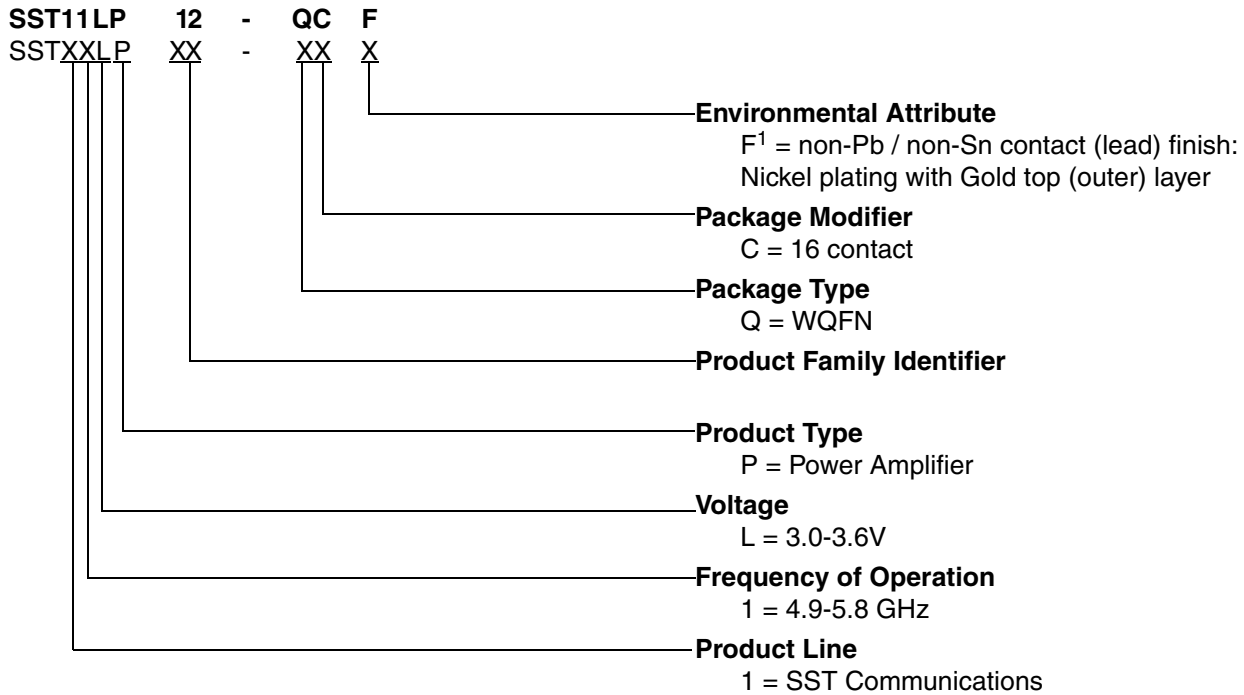

1. Environmental suffix "F" denotes non-Pb/non-Sn solder. SST non-Pb/non-Sn solder devices are "RoHS Compliant".

Valid combinations for SST11LP12

SST11LP12-QCF

SST11LP12 Evaluation Kits

SST11LP12-QCF-K

Note: Valid combinations are those products in mass production or will be in mass production. Consult your SST sales representative to confirm availability of valid combinations and to determine availability of new combinations.



4.9-5.8 GHz High-Linearity Power Amplifier SST11LP12

Preliminary Specifications

PACKAGING DIAGRAMS

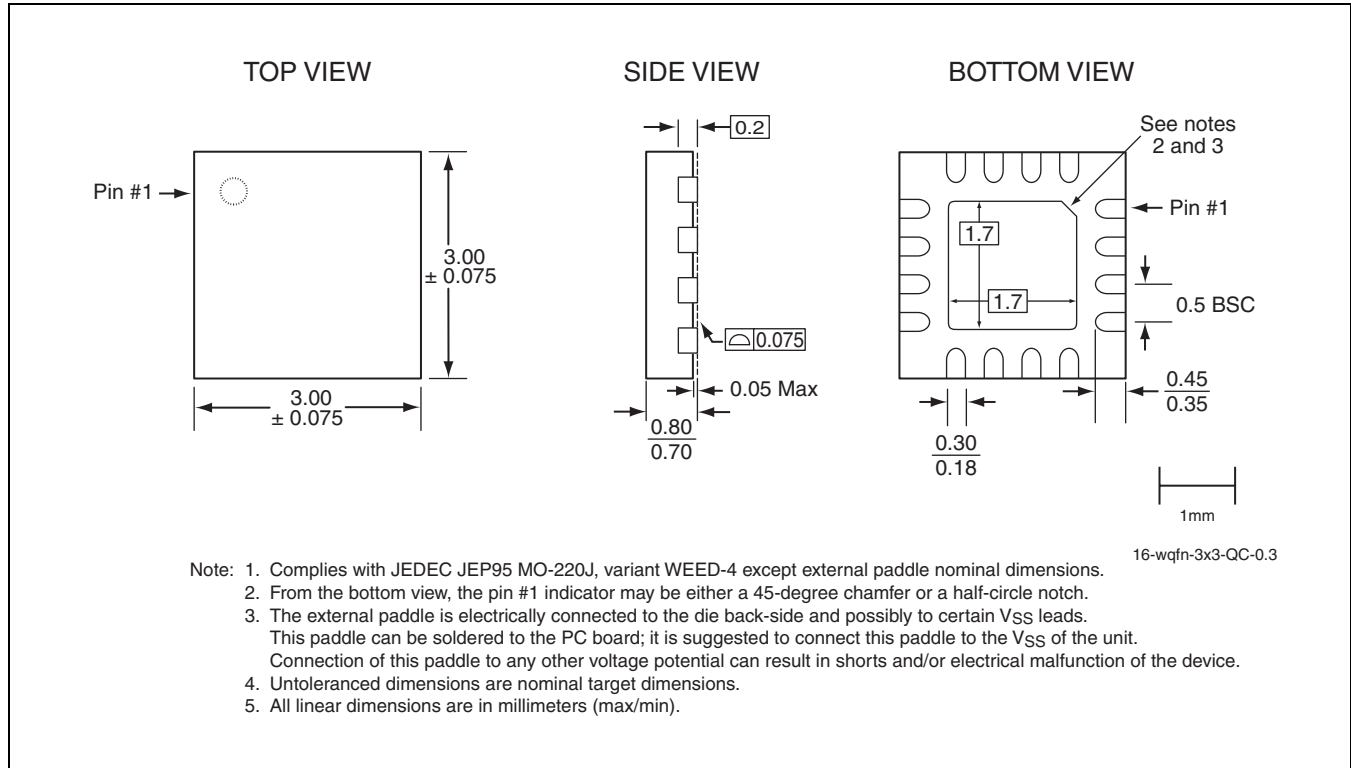

16-CONTACT VERY-THIN QUAD FLAT NO-LEAD (WQFN)
SST PACKAGE CODE: QC

TABLE 4: REVISION HISTORY

Revision	Description	Date
00	<ul style="list-style-type: none"> S71278: SST conversion of data sheet GP1112 	Jan 2005
01	<ul style="list-style-type: none"> Corrected the spectrum mask value in "Product Description" on page 1 to read 802.11a Corrected the solder reflow temperature under "Absolute Maximum Stress Ratings" on page 4 Updated sales and marketing contact information Changed VQFN to WQFN Updated Product Ordering information Updated Table 3 on page 5. 	Jan 2006



4.9-5.8 GHz High-Linearity Power Amplifier SST11LP12

Preliminary Specifications

CONTACT INFORMATION

Marketing

SST Communications Corp.

5340 Alla Road, Ste. 210
Los Angeles, CA 90066
Tel: 310-577-3600
Fax: 310-577-3605

Sales

NORTH AMERICA

Silicon Storage Technology, Inc.

Les Crowder
Technical Sales Support - North America
Tel: 949-495-6437
Fax: 949-495-6364
E-mail: lcrowder@sst.com

ASIA PACIFIC NORTH

SST Macao

H. H. Chang
Senior Director, Sales
Room N, 6th Floor,
Macao Finance Center, No. 202A-246,
Rua de Pequim, Macau
Tel: (853) 706-022
Fax: (853) 706-023
E-mail: hchang@sst.com

EUROPE

Silicon Storage Technology Ltd.

Ralph Thomson
Applications Manager
Mark House
9-11 Queens Road
Hersham KT12 5LU UK
Tel: +44 (0) 1869 321 431
Cell: +44 (0) 7787 508 919
E-mail: rthomson@sst.com

ASIA PACIFIC SOUTH

SST Communications Co.

Sunny Tzeng
Sales Manager
4F-2, No. 24, Lane 123, Sec.6,
Min Chuan E. Rd
Taipei 114, Taiwan, R.O.C.
Tel: +886-22795-6877 Ext. 163
Fax: +886-9792-1241
E-mail: stzeng@sst.com

JAPAN

SST Japan

Jun Kamata
Sales Director
9F Toshin-Tameike Bldg, 1-1-14 Akasaka,
Minato-ku, Tokyo, Japan 107-0052
Tel: (81) 3-5575-5515
Fax: (81) 3-5575-5516
Email: jkamata@sst.com

KOREA

SST Korea

Charlie Shin
Country Manager
Rm# 1101 DonGu Root Bldg, 16-2 Sunae-Dong,
Bundang-Gu, Sungnam, Kyunggi-Do
Korea, 463-020
Tel: (82) 31-715-9138
Fax: (82) 31-715-9137
Email: cshin@sst.com

Silicon Storage Technology, Inc. • 1171 Sonora Court • Sunnyvale, CA 94086 • Telephone 408-735-9110 • Fax 408-735-9036
www.SuperFlash.com or www.sst.com
